



- Batente de câmara europeia.
- Perfis extrudidos em liga 6063.
- Espessura geral 1,4 mm.
- Montagem de vidros com bites de pressão ou com molas.
- Juntas de estanquidade em EPDM
- Esquadros e juntas de batente comuns para todos os sistemas de batente.
- Esquadros de união em alumínio extrudido
- Esquadros de alinhamento em aço inox e zamak.
- Drenagem oculta de folha.
- Profundidade do aro 40 mm e folha 48 mm.
- Possibilidade de combinar aros, folhas e bites retos e curvos.

- À frappe chambre européenne.
- Profilés en extrusion d'alliage 6063.
- Epaisseur générale 1,4 mm.
- Vitrage au moyen de parcloses à talon ou à agrafes.
- Joints d'étanchéité en EPDM
- Equerres et joints de battant communs pour tous les systèmes praticables.
- Equerres d'assemblage en aluminium extrudé
- Equerres d'alignement en acier inox et zamak.
- Drainage d'ouvrant invisible.
- Profondeur du dormant 40 mm.
- Profondeur d'ouvrant 48 mm.
- Possibilité de combiner dormants, ouvrants et parcloses droits et arrondis.

2300 | TE

sistema de batente
câmara europeia

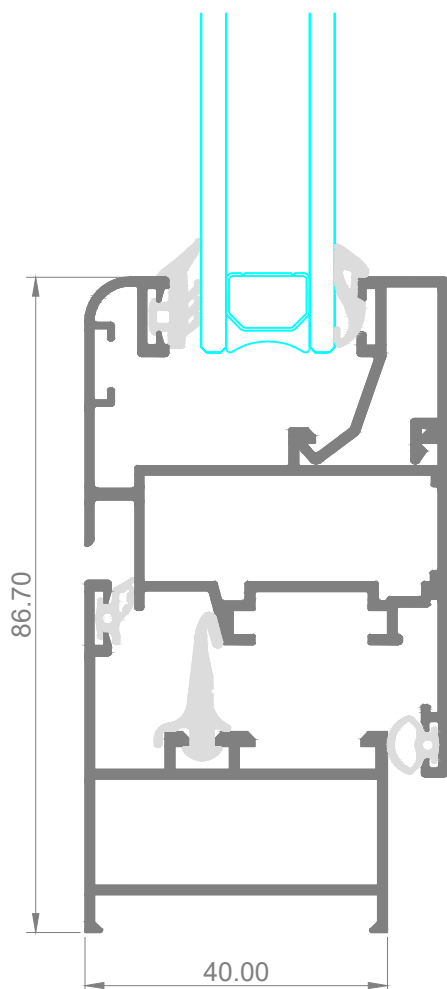

Resistência à acção do vento	Classe C5
Permeabilidade ao ar	Classe 4
Estanquidade à água	Classe 9A
Substâncias perigosas	NPD
Capacidade de suporte de carga dos dispositivos de segurança	APTO
Desempenho acústico	39 dB
Transmitância térmica (Uw)	desde 1,8 W/m ² K

Resistance à la charge de vent	Classe C5
Perméabilité à l'air	Classe 4
Etanchéité à l'eau	Classe 9A
Substances dangereuses	NPD
Capacité de support de charge des dispositifs de sécurité	APTE
Caractéristiques acoustiques	39 dB
Transmittance thermique (Uw)	depuis 1,8 W/m ² K

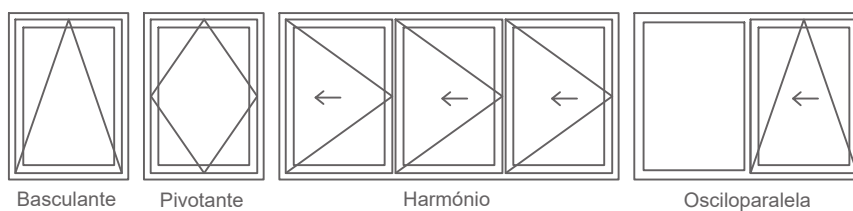
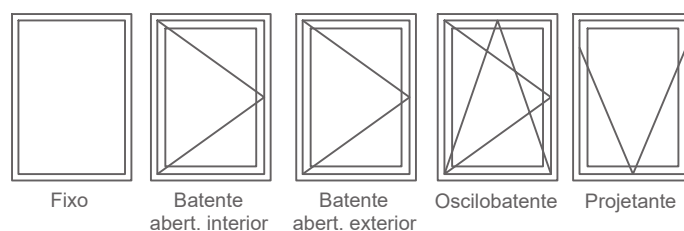

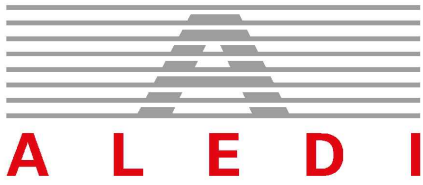

2300 | TE

sistema de batente
câmara europeia

AB2322

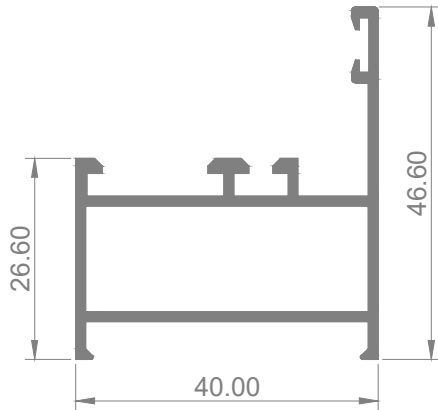

AB2301

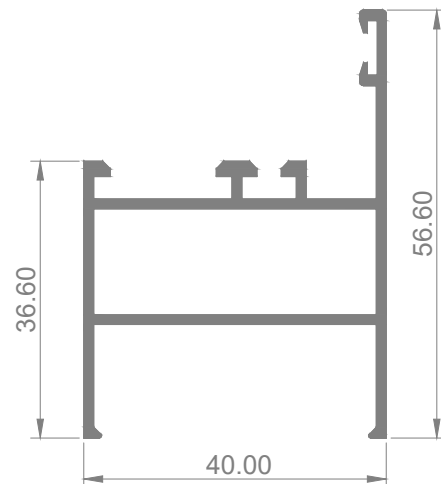

AB2342

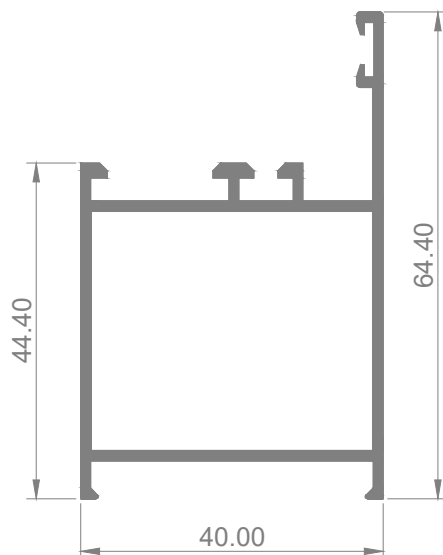

2300 | TE

sistema de batente
câmara europeia

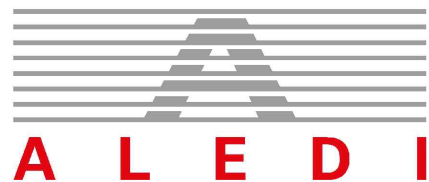

AB2332

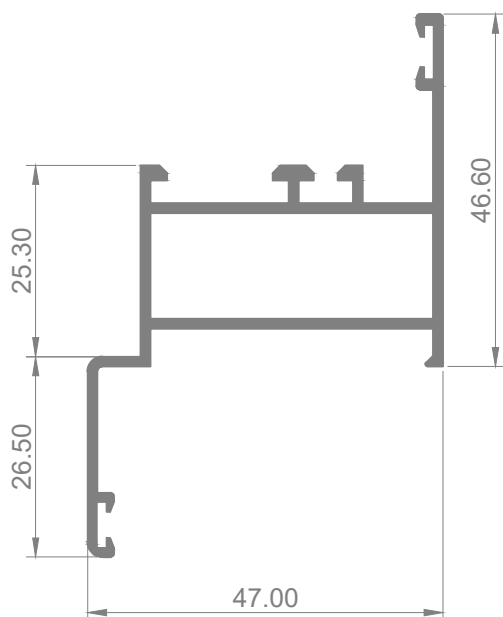

AB2362

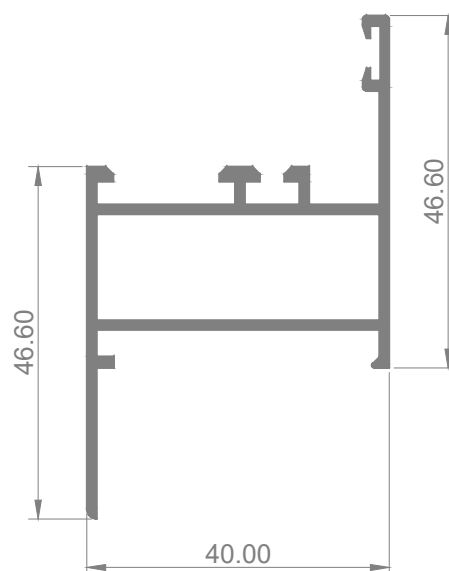

TE2068

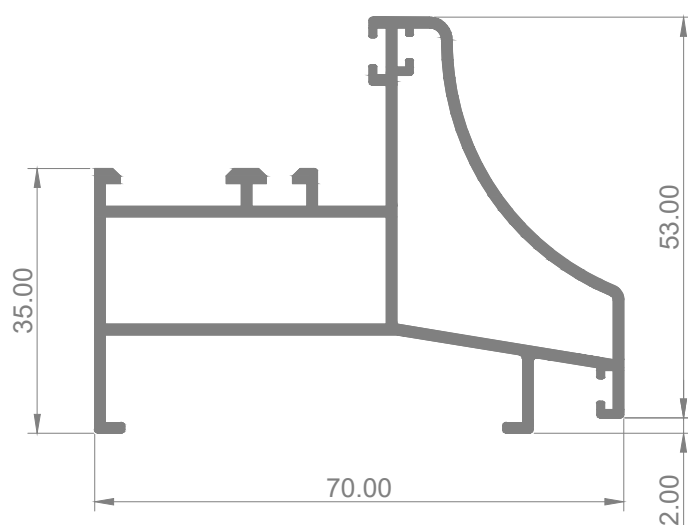

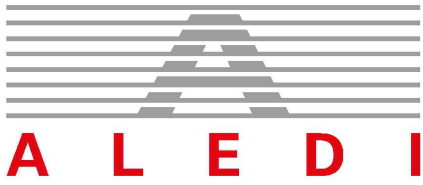

2300 | TE

sistema de batente
câmara europeia

AB2396

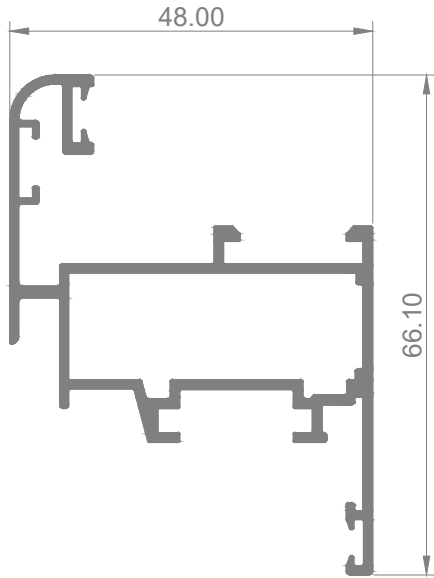

AB2406

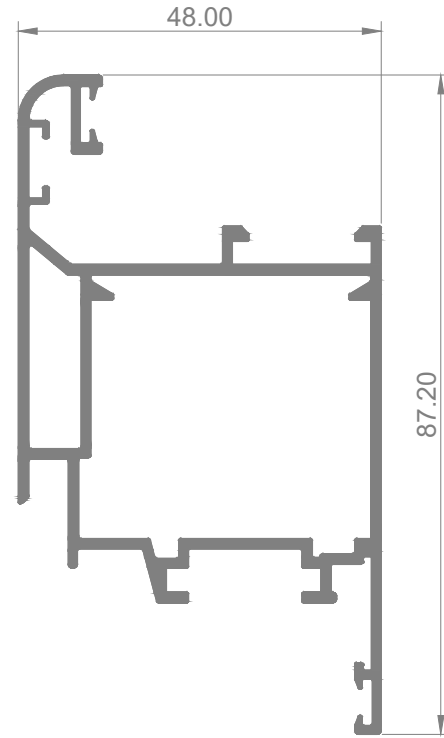

AB2405

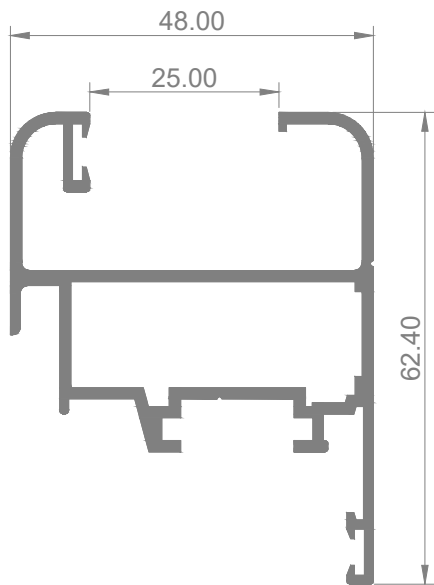

AB2404

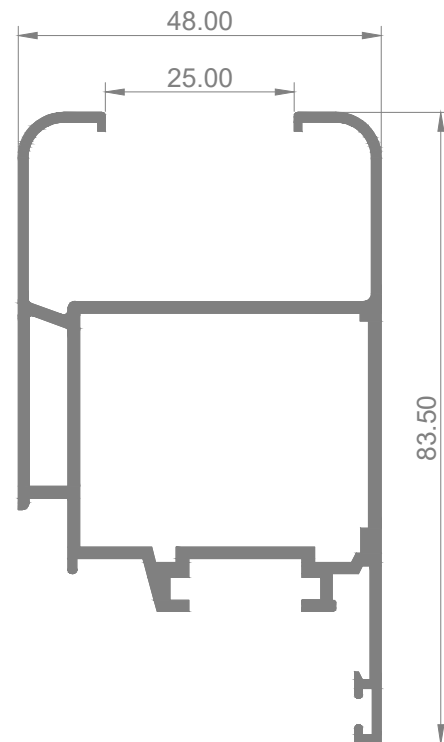

2300 | TE

sistema de batente
câmara europeia

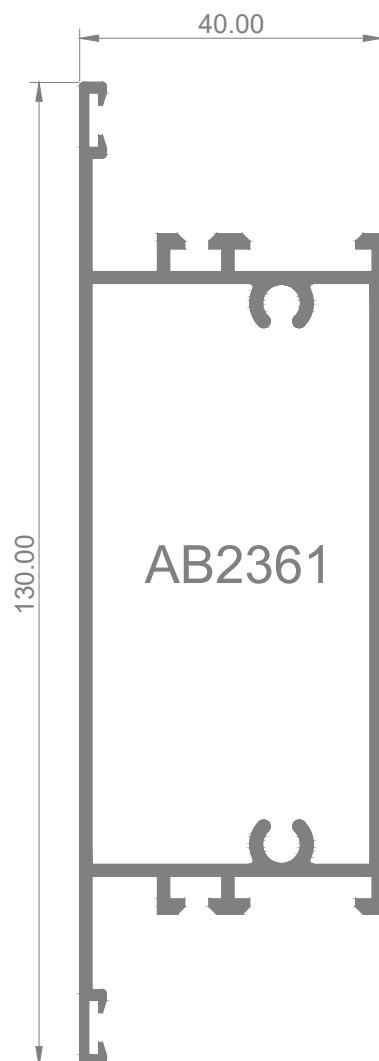
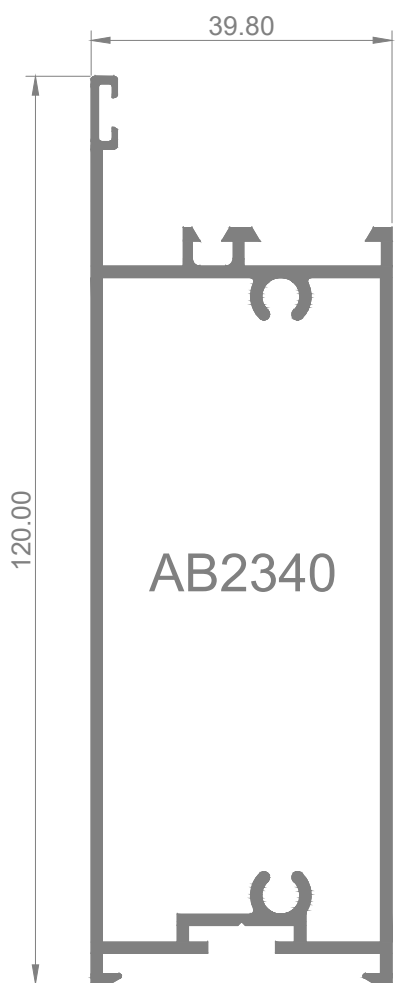
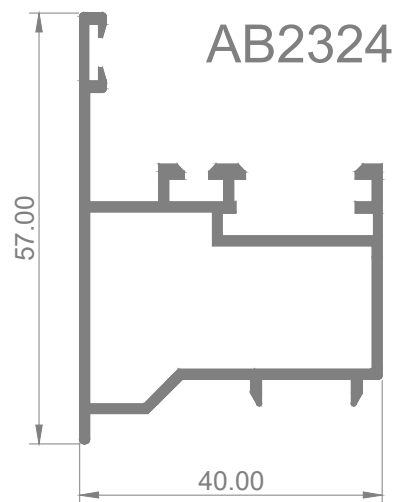
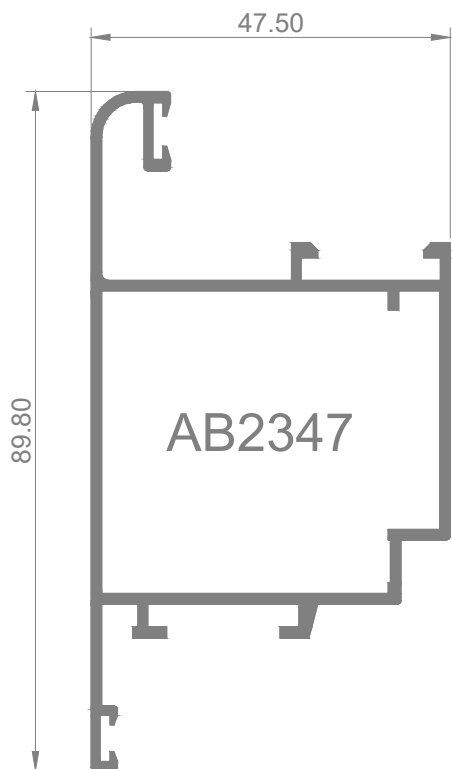
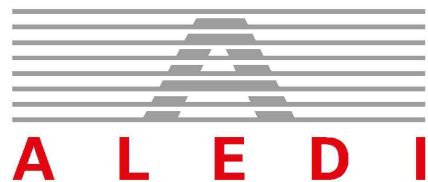

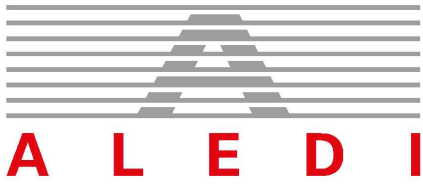

2300 | TE

sistema de batente
câmara europeia

AB2333

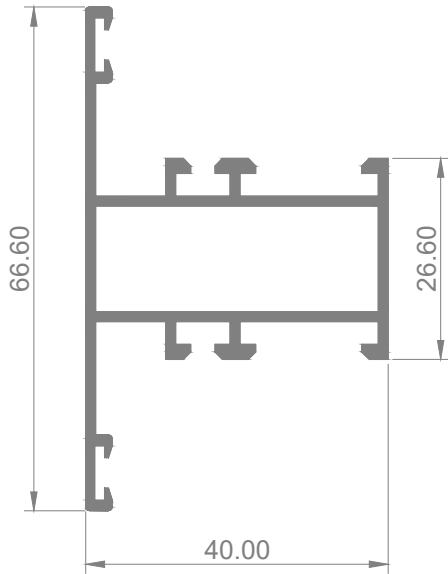

TE2002

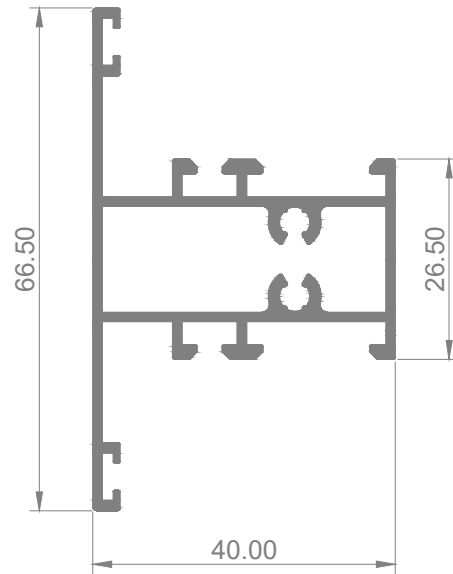

AB2343

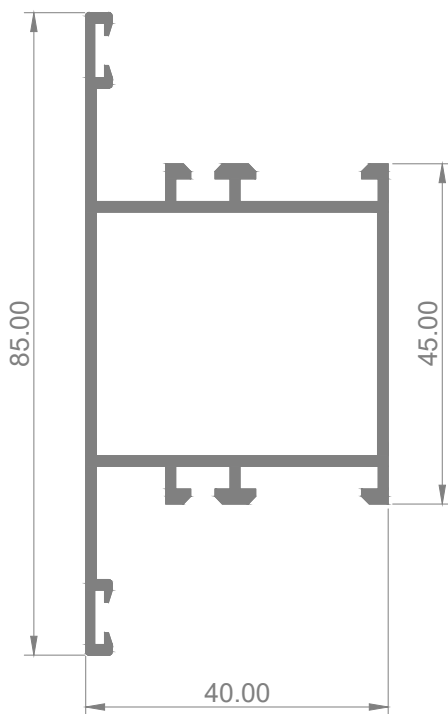

TE2139

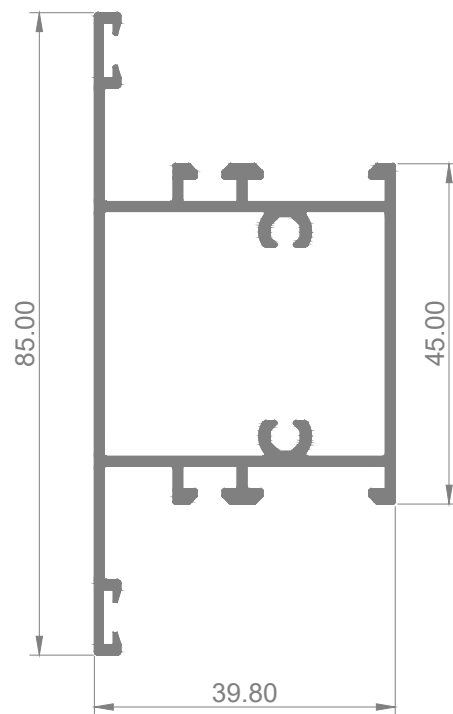

2300 | TE

sistema de batente
câmara europeia

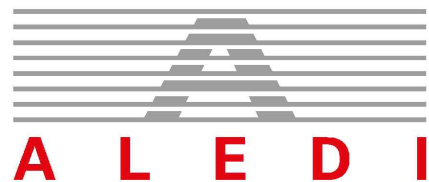

TE2023

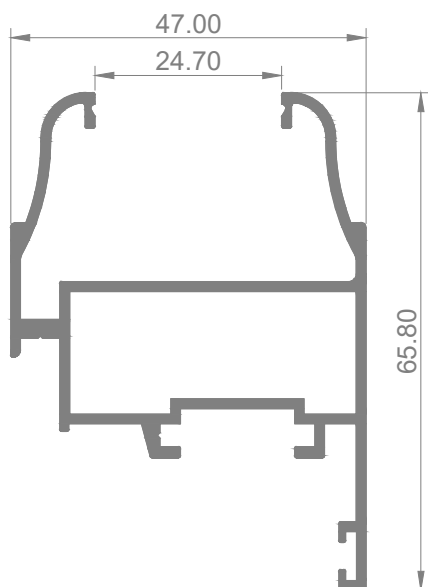

TE2033

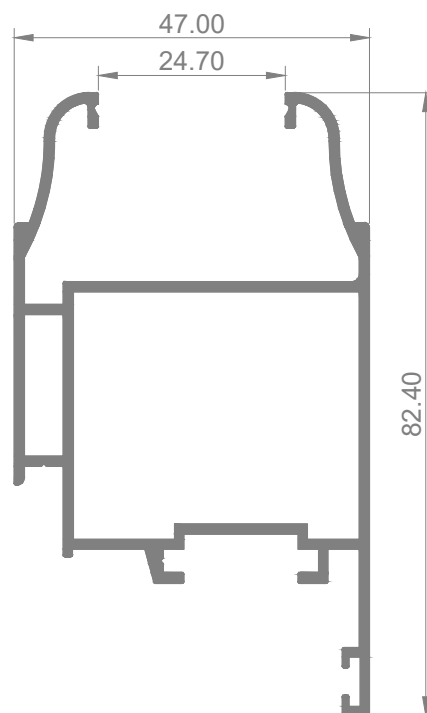

TE2035

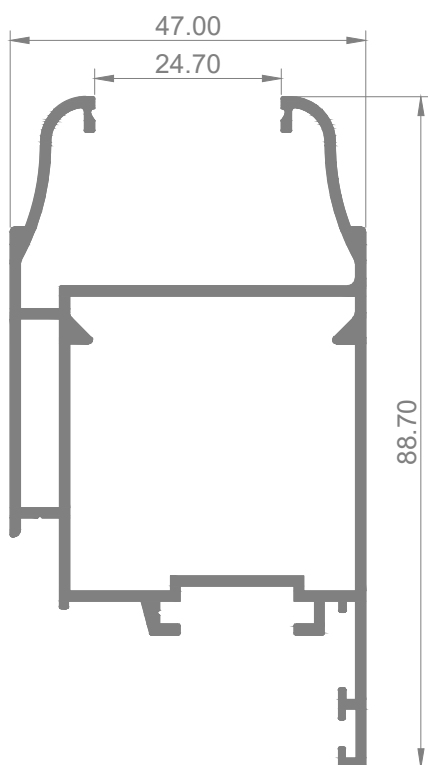

TE2148

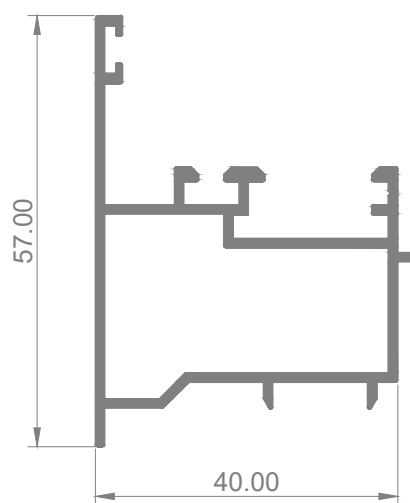

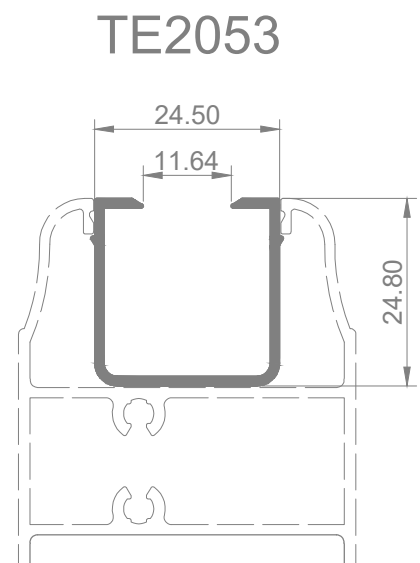
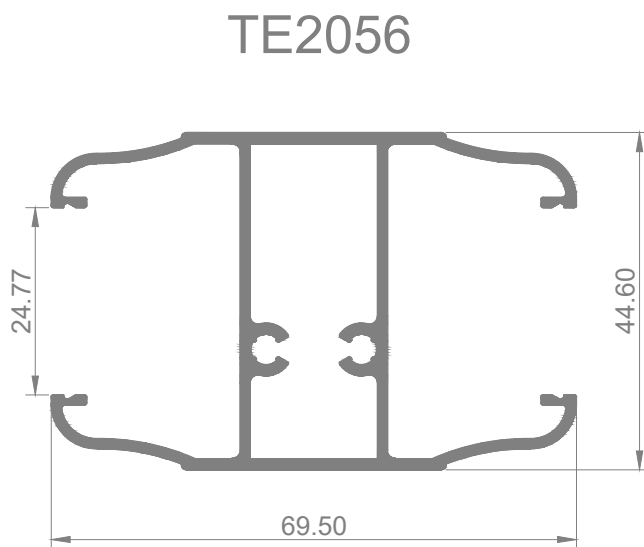
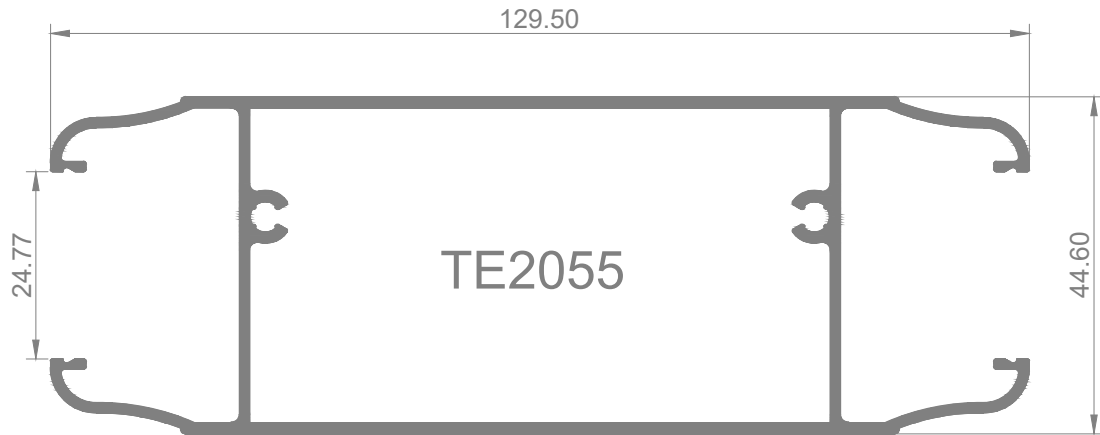

2300 | TE

sistema de batente
câmara europeia

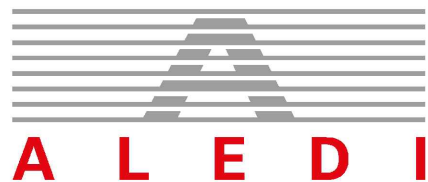

AB2410

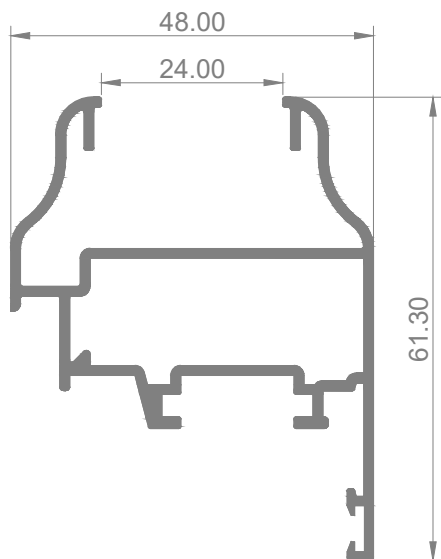

AB2411

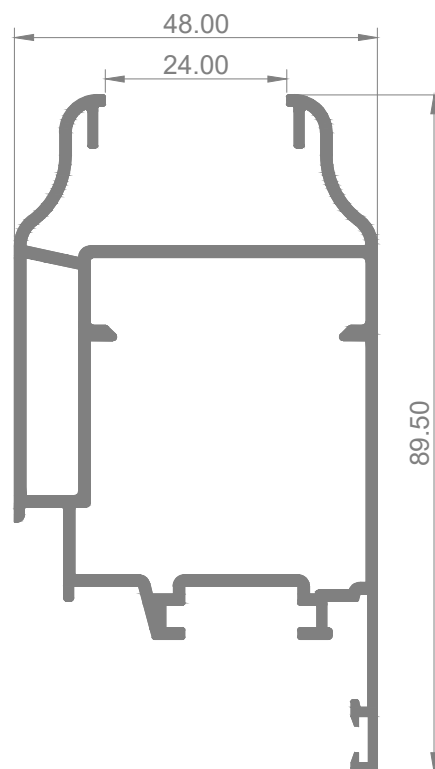

AB2412

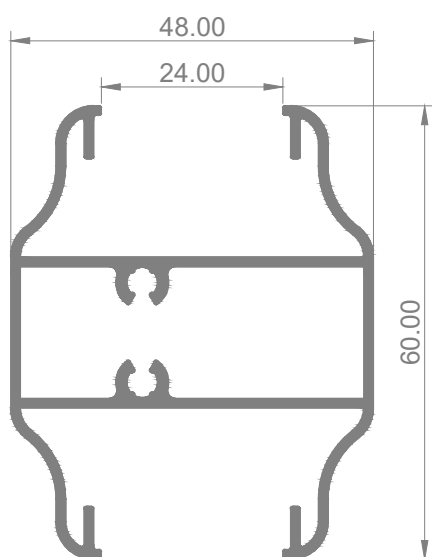

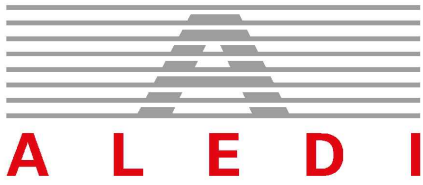

2300 | TE

sistema de batente
câmara europeia

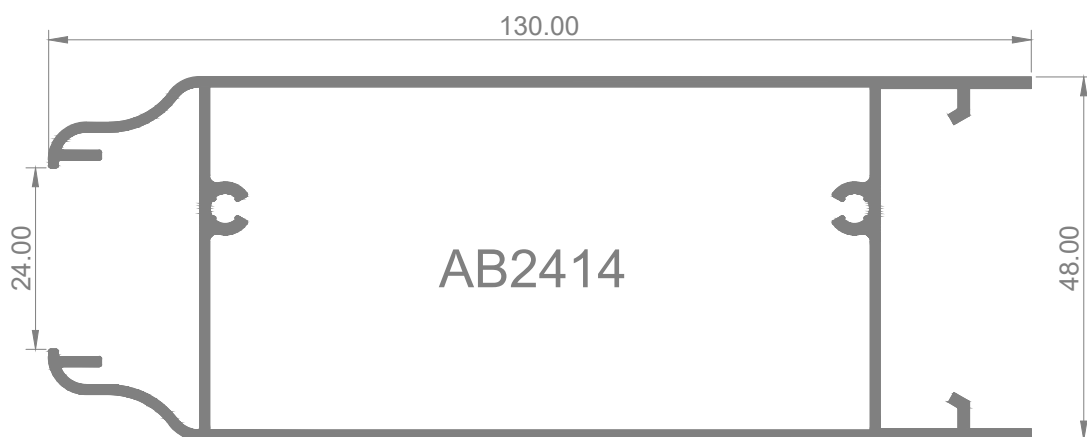
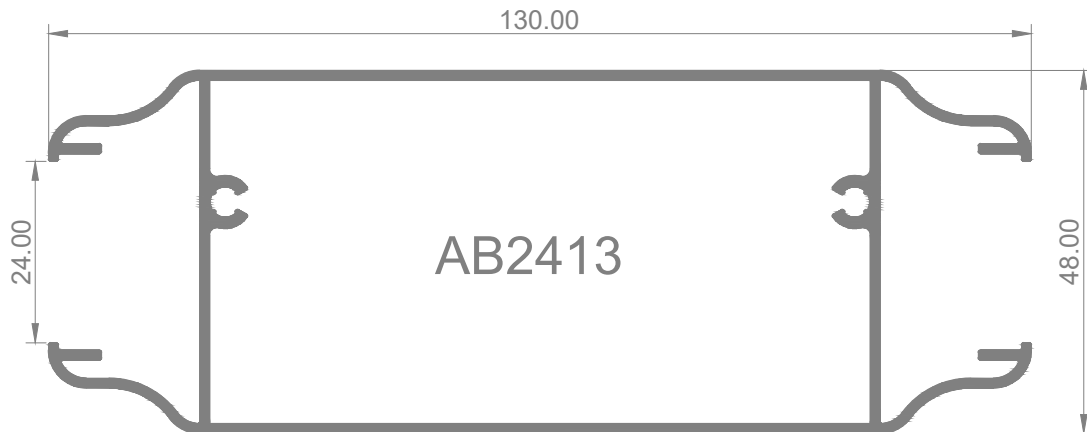

2300 | TE

sistema de batente
câmara europeia

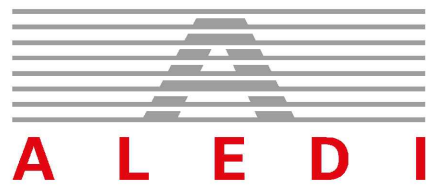

AB2331

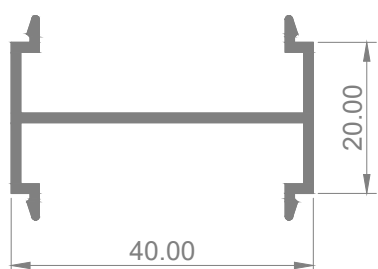

AB2356

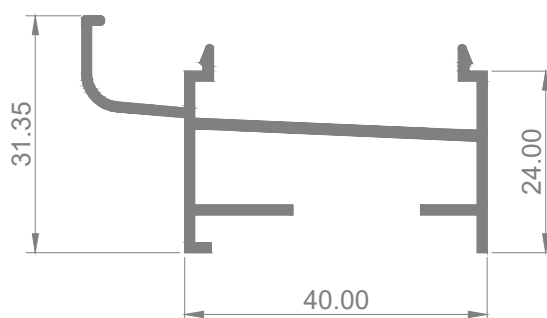

AB700730

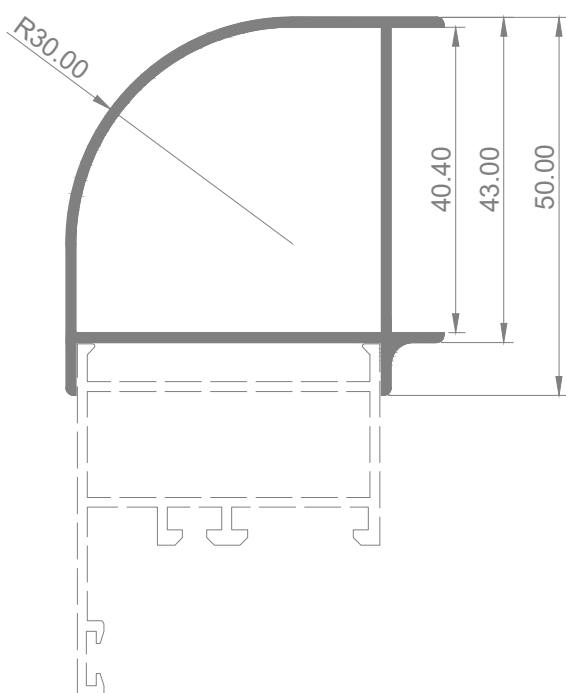

RT-7058

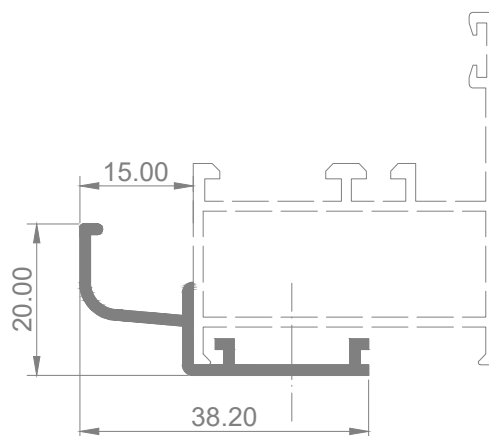

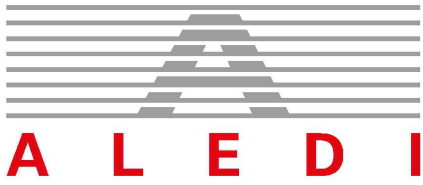

2300 | TE

sistema de batente
câmara europeia

AB2307

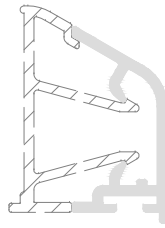
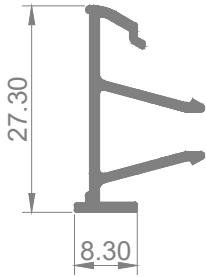

AB2304

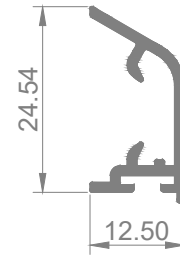

AB2030



AB2370

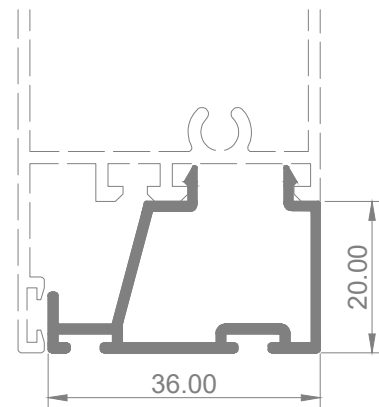

PK40-91

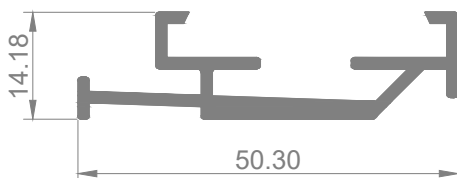

PK40-90

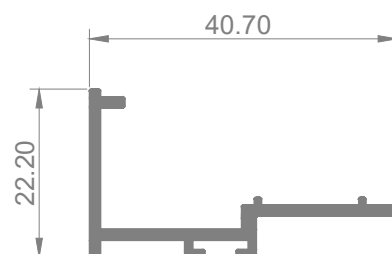

2300 | TE

sistema de batente
câmara europeia

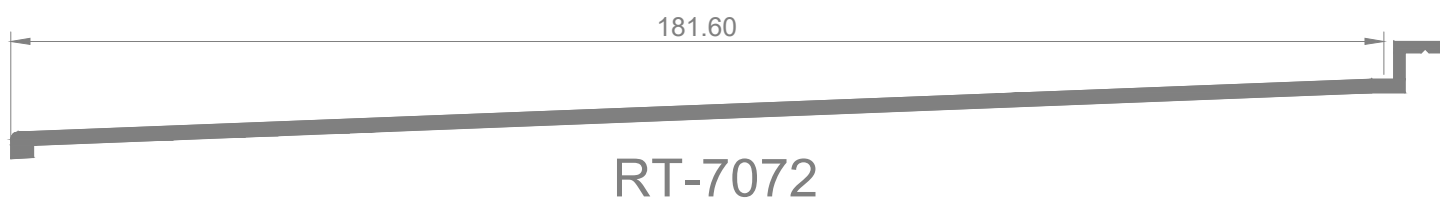
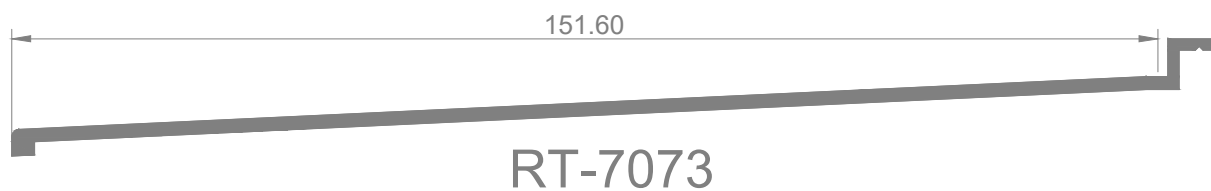
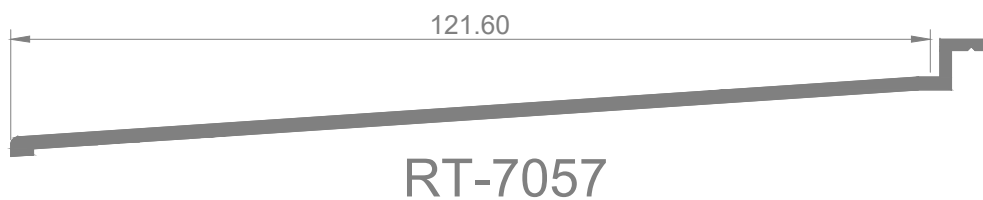
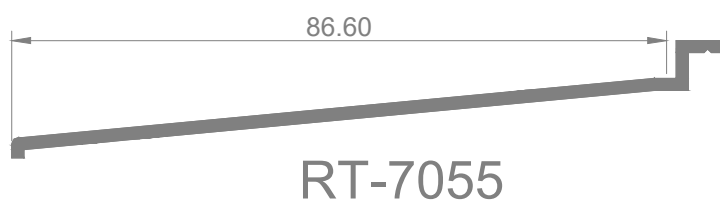
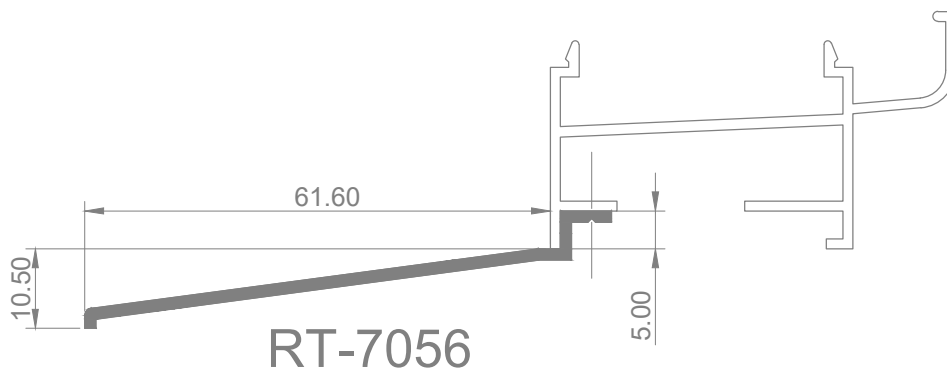
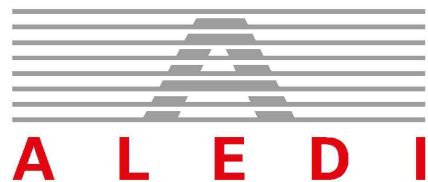

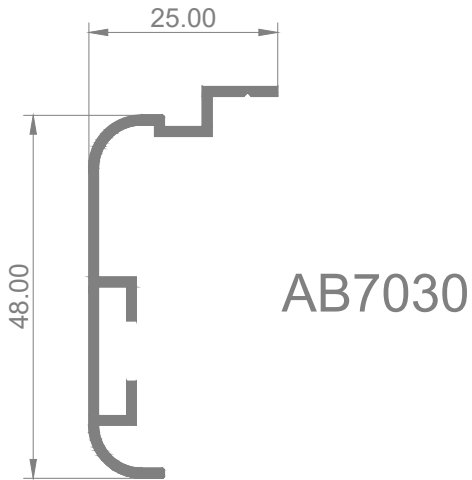

AB2036

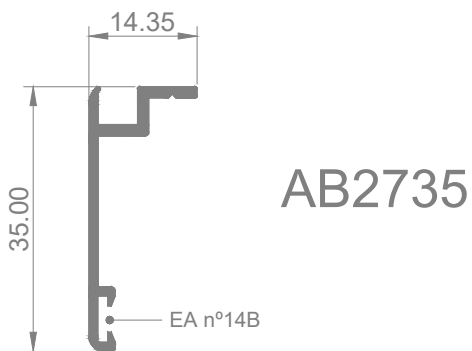
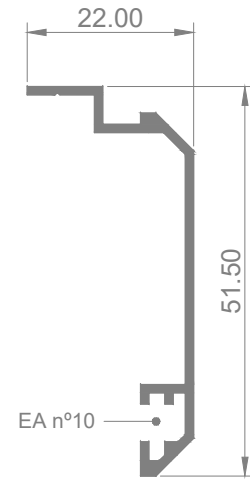

AB6524

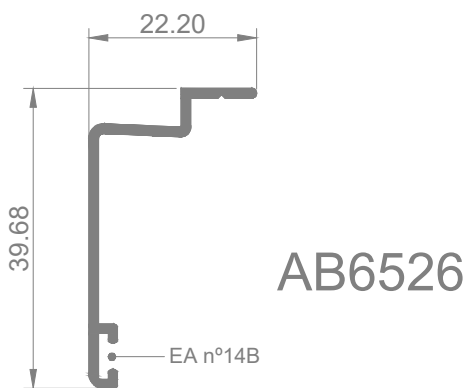
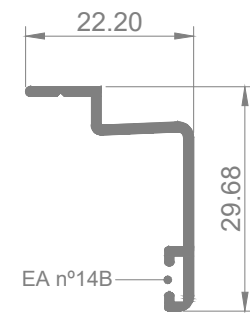



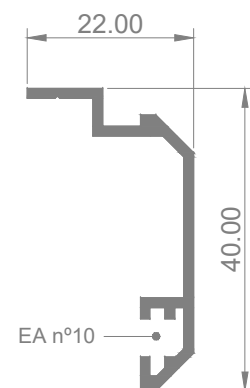





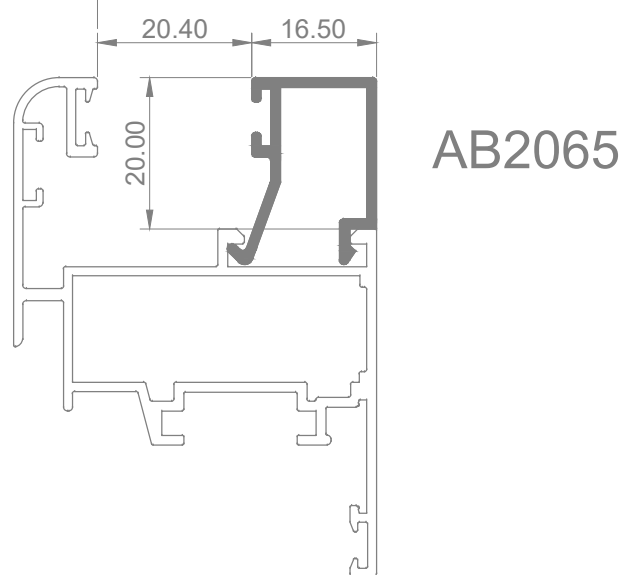
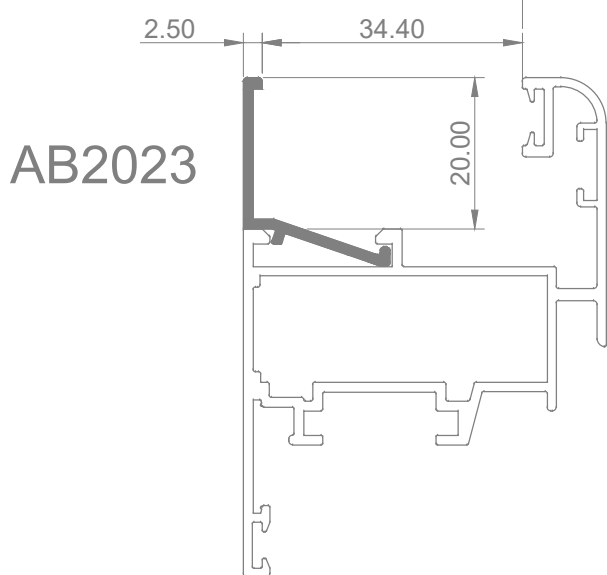
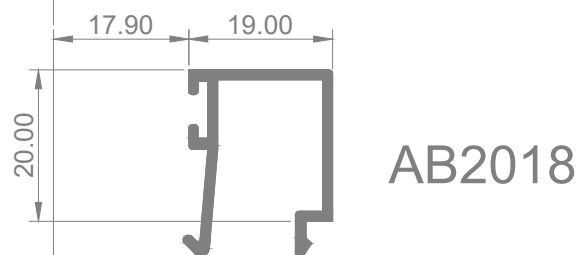
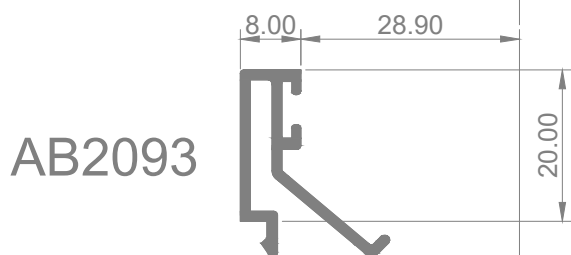
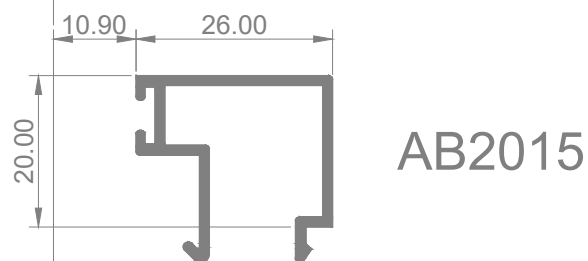
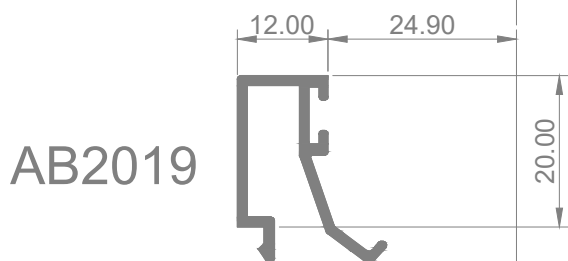
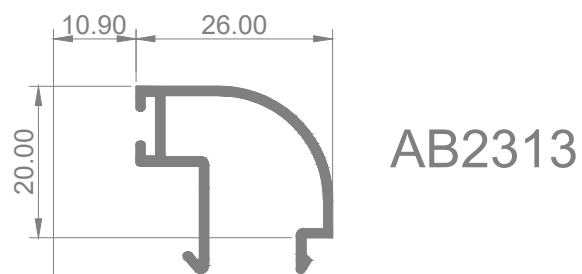
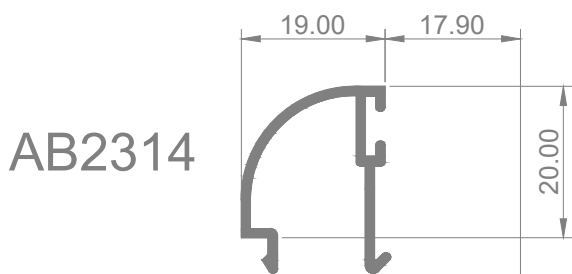
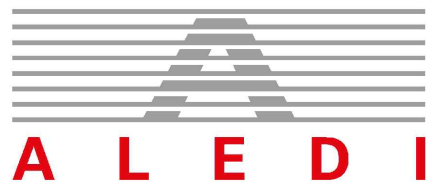



GAL1001



2300 | TE

sistema de batente
câmara europeia





 <p>4163 Vedante Batente exterior</p>	 <p>014/6.5 Vedante Batente exterior</p>
 <p>4164 Vedante Batente interior</p>	 <p>03/5.5 Vedante Batente interior</p>
 <p>4000 Vedante Central</p>	 <p>4033 Vedante Vidro Exterior</p>
 <p>4195 Vedante Vidro Interior 3.5-5mm</p>	 <p>P 757-100-E1 Vedante Vidro Interior</p>
 <p>4194 Vedante Vidro Interior 5-7mm</p>	 <p>P 798-100-E1 Vedante Vidro Interior</p>
 <p>4193 Vedante Vidro Interior 7-10mm</p>	

2300 | TE

sistema de batente
câmara europeia

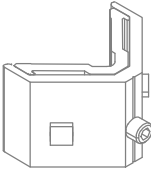
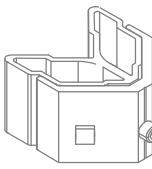
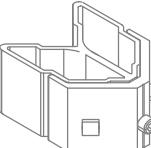
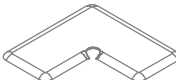
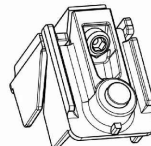
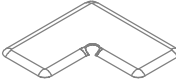
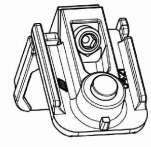

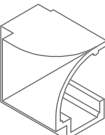
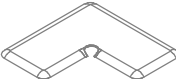
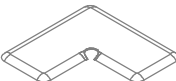
	<p>26-3714-C</p> <p>Esquadro AB: 2322, 2301, 2332, 2362 2396, 2405, 2410 TE: 2068, 2023</p>		<p>26-3731-C</p> <p>Esquadro AB: 2342, 2406, 2404, 2411 TE: 2033, 2035</p>
	<p>26-3840 150</p> <p>Esquadro AB2347</p>		<p>EA 228/9 mm</p> <p>Esquadro de alinhamento</p>
	<p>406</p> <p>Esquadro AB: 2342, 2406, 2404, 2411 TE: 2033, 2035</p>		<p>EA nº41</p> <p>Esquadro de alinhamento</p>
	<p>421</p> <p>Esquadro AB: 2322, 2301, 2332, 2362 2396, 2405, 2410 TE: 2068, 2023</p>		<p>EA nº3</p> <p>Esquadro de alinhamento 38x12.8x1</p>
	<p>Canto para bites redondos</p>		<p>EA nº10</p> <p>Esquadro de alinhamento 50x8.8</p>
			<p>EA nº14B</p> <p>Esquadro de alinhamento 25x5.8</p>

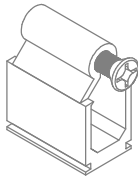
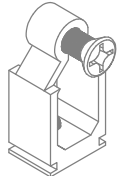
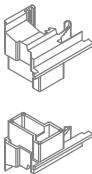
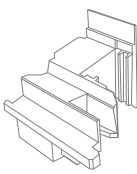
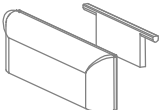
 <p>UNIÃO CE G União travessa CE grande</p>	 <p>UNIÃO CE P União travessa CE pequena</p>
 <p>255P Topo Inversor Rígido AB2324 TE2148</p>	 <p>S/2300 Topo Inversor Borracha AB2324 TE2148</p>
 <p>9001 (B/P) Goteira branco/preto</p>	

2300 | TE

sistema de batente
câmara europeia

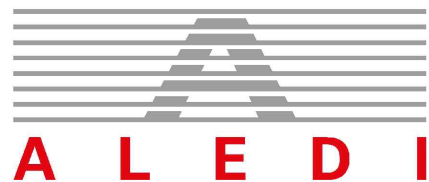

Fixo





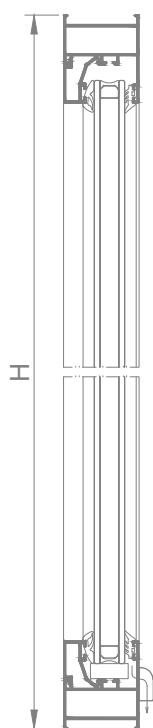

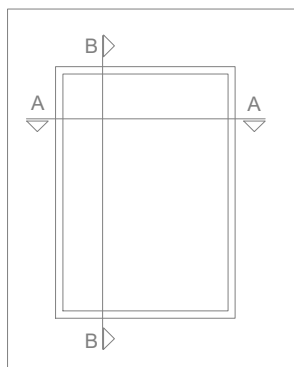

Corte A - A



Corte B - B



	Ref.	Descrição	Horizontal		
			Corte	Quantidade	Medida
	AB2322	Aro fixo estreito		2	L
				2	H
		Bite		2	L - 53.2
				2	H - 93.2

Janela de 1 folha abertura interior

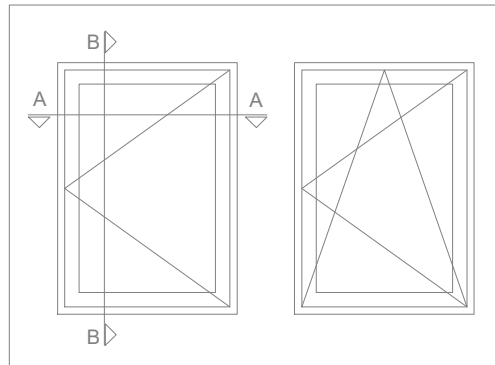
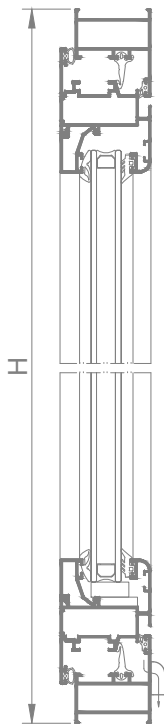
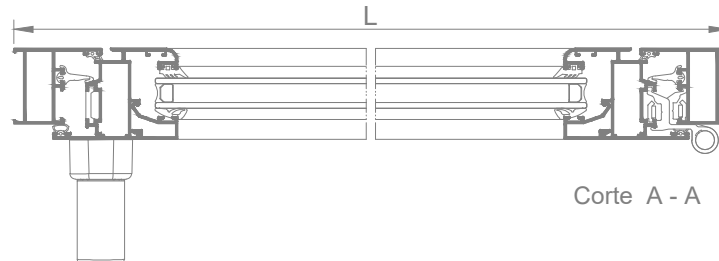

	Ref.	Descrição	Horizontal		
			Corte	Quantidade	Medida
	AB2322	Aro fixo estreito		2	L
				2	H
	AB2396	Folha de janela		2	L - 41.2
				2	H - 41.2
		Bite		2	L - 133.4
				2	H - 173.4
	AB2030	Barra de cremone			

2300 | TE

sistema de batente
câmara europeia



Janela de 2 folhas abertura interior

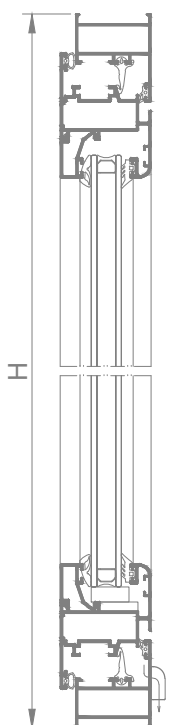
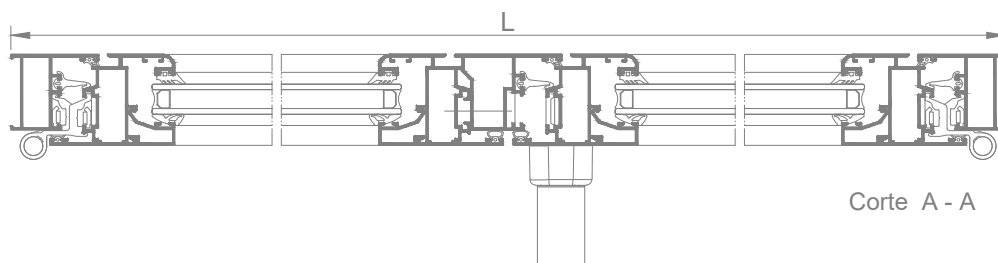



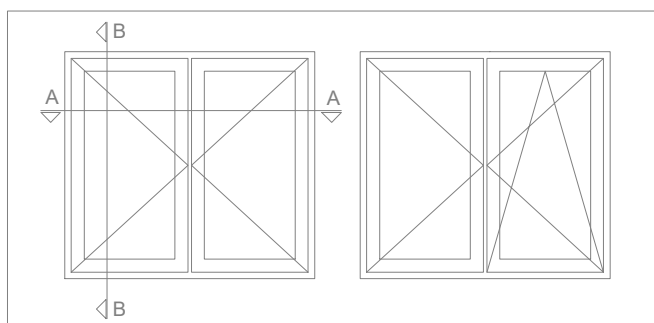





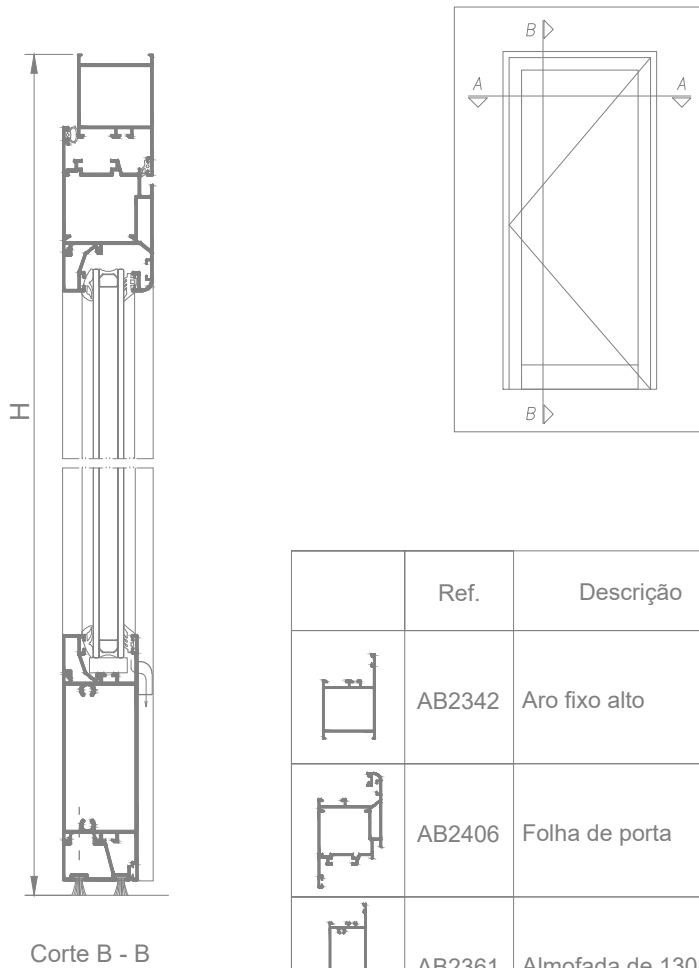
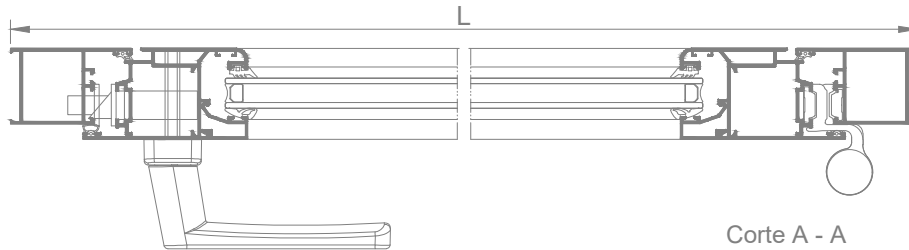

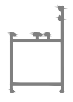

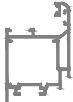
Corte B - B

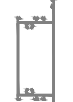

	Ref.	Descrição	Horizontal		
			Corte	Quantidade	Medida
	AB2322	Aro fixo estreito		2	L
				2	H
	AB2396	Folha de janela		4	L/2 - 23.1
				4	H - 41.2
	AB2324	Inversor		1	H - 111.2
		Bite		4	L/2 - 115.3
				4	H - 173.4
	AB2030	Barra de cremone			

Porta de 1 folha abertura interior



	Ref.	Descrição	Horizontal		
			Corte	Quantidade	Medida
	AB2342	Aro fixo alto		1	L
				2	H
	AB2406	Folha de porta		1	L - 76.8
				2	H - 46.1
	AB2361	Almofada de 130mm		1	L - 201.2
	AB2370	Remate inferior de porta		1	L - 211.2
		Bite		2	L - 211.2
				2	H - 263.3
	AB2030	Barra de cremone			

2300 | TE

sistema de batente
câmara europeia

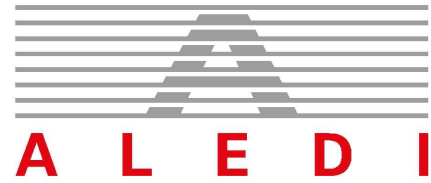

Porta de 2 folhas abertura interior

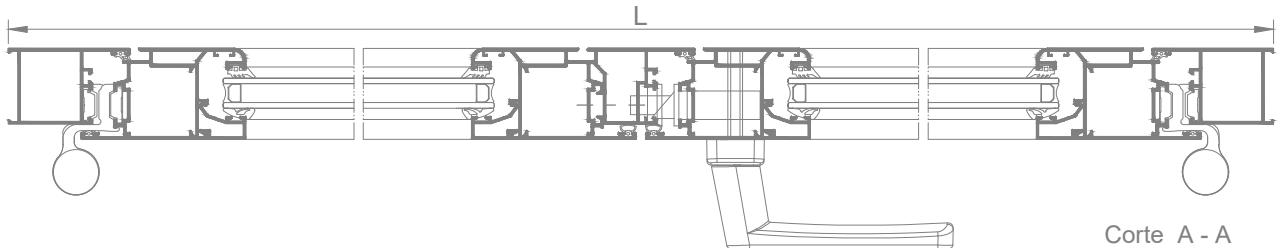

Corte A - A

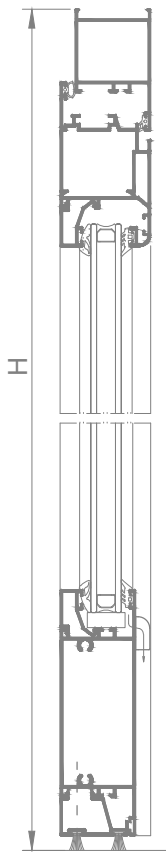



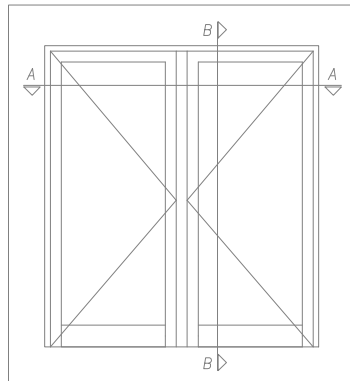





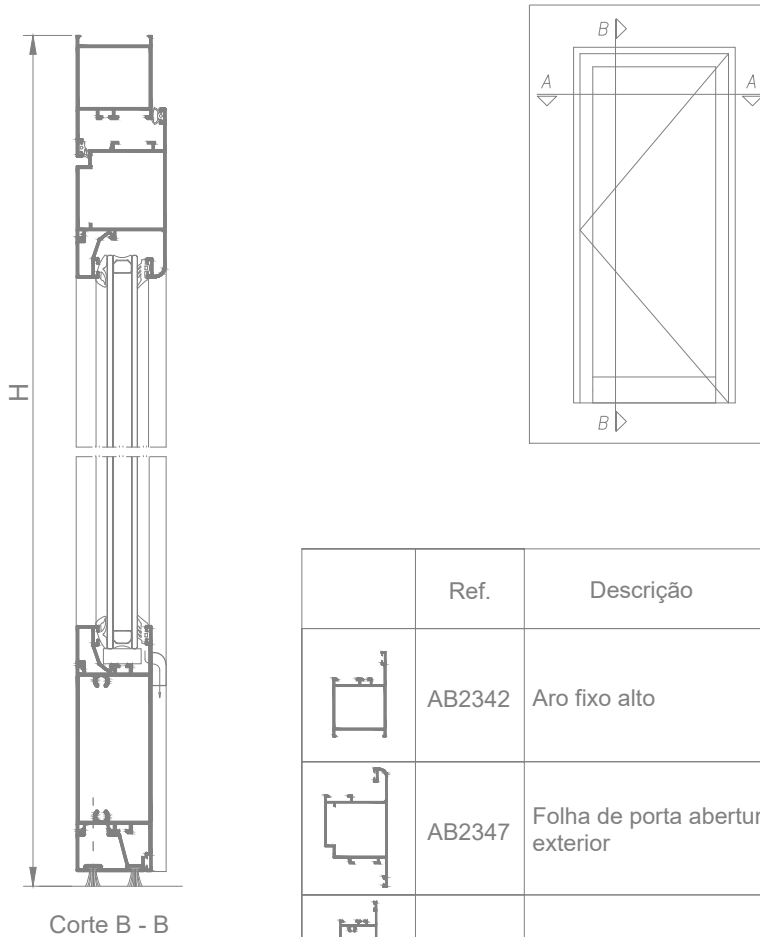
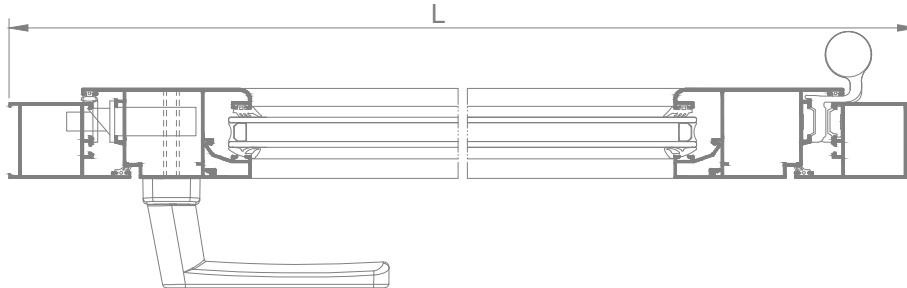





Corte B - B

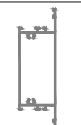

	Ref.	Descrição	Horizontal		
			Corte	Quantidade	Medida
	AB2342	Aro fixo alto		1	L
				2	H
	AB2406	Folha de porta		2	L/2 - 40.9
				4	H - 46.1
	AB2324	Inversor		1	H - 78.6
	AB2361	Almofada de 130mm		2	L/2 - 165.3
	AB2370	Remate inferior de porta		2	L/2 - 175.3
		Bite		4	L/2 - 175.3
				4	H - 263.3
	AB2030	Barra de cremone			

Porta de 1 folha abertura exterior



	Ref.	Descrição	Horizontal		
			Corte	Quantidade	Medida
	AB2342	Aro fixo alto		1	L
				2	H
	AB2347	Folha de porta abertura exterior		1	L - 76.8
				2	H - 46.1
	AB2361	Almofada de 130mm		1	L - 206.4
	AB2370	Remate inferior de porta		1	L - 216.4
		Bite		2	L - 216.4
				2	H - 265.9
	AB2030	Barra de cremone			

2300 | TE

sistema de batente
câmara europeia



Porta de 2 folhas abertura exterior

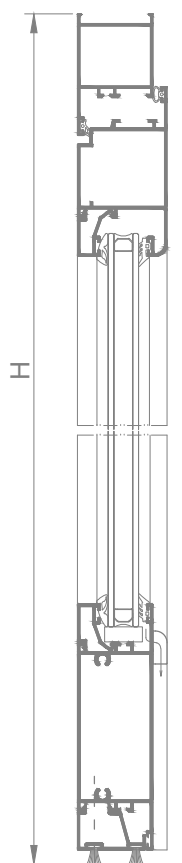
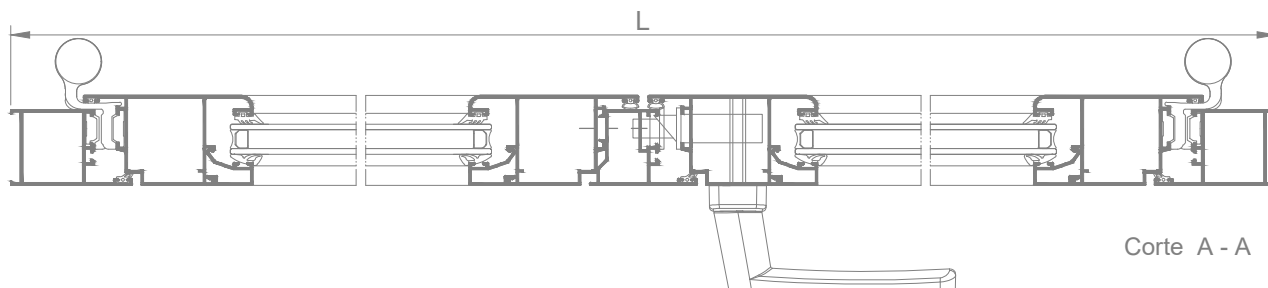

Corte B - B

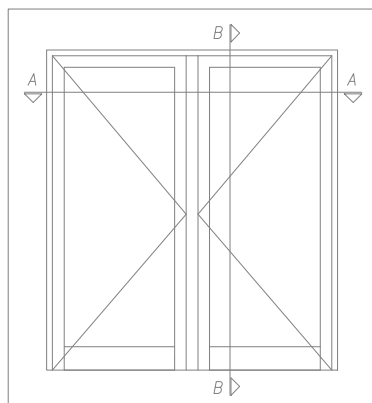

	Ref.	Descrição	Horizontal		
			Corte	Quantidade	Medida
	AB2342	Aro fixo alto		1	L
				2	H
	AB2347	Folha de porta abertura exterior		2	L/2 - 40.9
				4	H - 46.1
	AB2324	Inversor		1	H - 71.1
	AB2361	Almofada de 130mm		2	L/2 - 170.5
	AB2370	Remate inferior de porta		2	L/2 - 180.5
	Bite			4	L/2 - 180.5
				4	H - 265.9
	AB2030	Barra de cremone			



